

DESCRIPCION TÉCNICA

Producto : Sistema Jakin

Diseño : Abad diseño

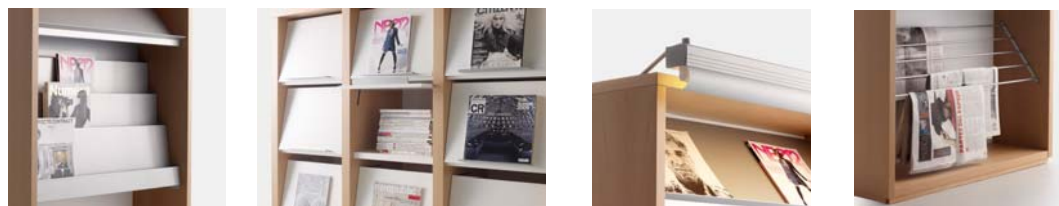

Laterales de madera

S - Separador Normal / ST - Separador Terminal (Espesor 3,1 cm)

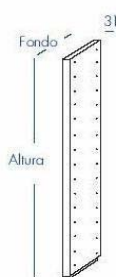

Distancia entre taladros de la cremallera 3,2 cm.

Posibilidad de colgar :

Altos: ② ③ ④ ⑤ ⑥
Fondos: F30

		F/30	F/45	F/60
②	Separador altura 38 cm	X	X	X
③	Separador altura 54 cm	X	X	X
④	Separador altura 70 cm	X	X	X
⑤	Separador altura 86 cm	X	X	X
⑥	Separador altura 102 cm	X	X	X
⑦	Separador altura 118 cm	X	X	X
⑧	Separador altura 134 cm	X	X	X
⑨	Separador altura 150 cm	X	X	X
⑩	Separador altura 166 cm	X	X	X
⑪	Separador altura 182 cm	X	X	X
⑫	Separador altura 198 cm	X	X	X
⑬	Separador altura 214 cm	X	X	X
⑭	Separador altura 230 cm	X	X	X
⑮	Separador altura 246 cm	X	X	X
⑯	Separador altura 262 cm	X	X	X
⑰	Separador altura 278 cm	X	-	-
⑱	Separador altura 294 cm	X	-	-

SG - Separador Grueso / SGT - Separador Grueso Terminal (Espesor 5 cm)

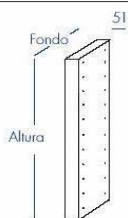

Distancia entre taladros de la cremallera 3,2 cm.
Siempre sobre suelo.

		F/30	F/45
⑩	Separador altura 166 cm	X	X
⑫	Separador altura 198 cm	X	X
⑭	Separador altura 230 cm	X	X

Encimeras

E- CORR - Encimera

	F/30	F/45	F/60	F/75
m. lineal	X	X	X	X



DESCRIPCION TÉCNICA

Producto : Sistema Jakin

Diseño : Abad diseño

Rodapiés

RR - Rodapiés de Rincón

X	Y	X	Y	X	Y	X	Y
30	30	30	45	45	30	45	45
X		X		X		X	

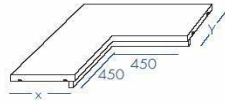

R - Rodapiés / RB - Rodapiés Bifacial

F/30 F/45 F/60



Rodapié ancho	F/30	F/45	F/60
30 cm	X	X	X
45 cm	X	X	X
60 cm	X	X	X
75 cm	X	X	X
90 cm	X	X	X
105 cm	X	X	X
120 cm	X	X	X

RT - Rodapiés con Tope / RBT - Rodapiés Bifacial con Tope

F/30 F/60

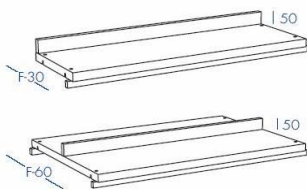

Rodapié ancho	F/30	F/60
30 cm	X	X
45 cm	X	X
60 cm	X	X
75 cm	X	X
90 cm	X	X
105 cm	X	X
120 cm	X	X

Versiones

Distintas versiones de separador

Hasta altura ② (Inclusiva) la encimera puede ser corrida

A partir de altura ② lo encimera irá entre costados

Distintas versiones de estantes y rodapiés

Con trasera Bifacial con 2 estantes Bifacial con 1 estante Con tope

Trasera Puerta FRENTE Cajón Cajón FRENTE

DESCRIPCION TÉCNICA

Producto : Sistema Jakin

Diseño : Abad diseño

Estantes

EMET - Estante Metálico

F/30



Chapa 1,5 mm.
Capacidad de carga máxima: 60 Kilos.
Combinable con trasera o aspa.

Estante ancho 60 cm	X
Estante ancho 90 cm	X
Estante ancho 120 cm	X

EIM - Estante Inclinado Metálico

F/30

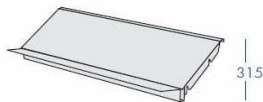

A emplear siempre con laterales de madera.
Combinable con trasera o aspa.

Estante ancho 60 cm	X
Estante ancho 90 cm	X

Estantes de Mediateca Metálico

EMD - Estante de Mediateca

F/30

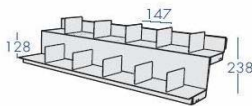

A emplear siempre con laterales de madera.
Divisores verticales con posición fija.
Hueco mínimo necesario 31 cm.
Combinable con trasera o aspa.

Estante ancho 90 cm	X
Estante ancho 120 cm	X

EMCD - Estante Metálico "CD"

F/30



A emplear siempre con laterales de madera.
Combinable con trasera o aspa.

Estante ancho 90 cm	X
Estante ancho 120 cm	X

EMDVD - Estante Metálico "DVD"

F/30

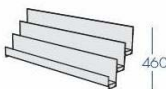

A emplear siempre con laterales de madera.
Combinable con trasera o aspa.

Estante ancho 90 cm	X
Estante ancho 120 cm	X

EMR - Estante Metálico "REVISTAS"

F/30

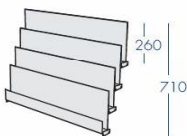

A emplear siempre con laterales de madera.
Combinable con trasera o aspa.

Estante ancho 90 cm	X
Estante ancho 120 cm	X

EC - Estante de Cristal

F/30 F/45 F/60



Estante ancho 30 cm	X	X	X
Estante ancho 45 cm	X	X	X
Estante ancho 60 cm	X	X	X
Estante ancho 75 cm	X	X	X
Estante ancho 90 cm	X	X	X

PP - Expositor de periódicos

F/30

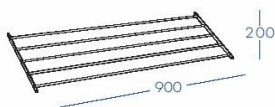

Expositor ancho 90 cm	X
Combinable con trasera o aspa.	

DESCRIPCION TÉCNICA

Producto : Sistema Jakin

Diseño : Abad diseño

Traseras

T - Trasera



Alto	Ancho							
	30	45	60	75	90	105	120	
② 29	X	X	X	X	X	X	X	
③ 45	X	X	X	X	X	X	X	
④ 61	X	X	X	X	X	X	X	
⑤ 77	X	X	X	X	X	X	X	
⑥ 93	X	X	X	X	X	X	X	
⑦ 109	X	X	X	X	X	X	X	
⑧ 125	X	X	X	X	X	X	X	
⑨ 141	X	X	X	X	X	X	X	
⑩ 157	X	X	X	X	X	X	X	
⑪ 173	X	X	X	X	X	X	X	
⑫ 189	X	X	X	X	X	X	X	
⑭ 221	X	X	X	X	X	X	X	
⑯ 253	X	X	X	X	X	X	X	

TB - Trasera bifacial

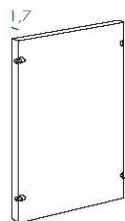

Alto	Ancho							
	30	45	60	75	90	105	120	
② 29	X	X	X	X	X	X	X	
③ 45	X	X	X	X	X	X	X	
④ 61	X	X	X	X	X	X	X	
⑤ 77	X	X	X	X	X	X	X	
⑥ 93	X	X	X	X	X	X	X	
⑦ 109	X	X	X	X	X	X	X	
⑧ 125	X	X	X	X	X	X	X	
⑨ 141	X	X	X	X	X	X	X	
⑩ 157	X	X	X	X	X	X	X	
⑪ 173	X	X	X	X	X	X	X	
⑫ 189	X	X	X	X	X	X	X	
⑭ 221	X	X	X	X	X	X	X	
⑯ 253	X	X	X	X	X	X	X	

Aspa

ASPA - Aspa

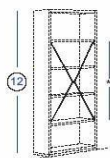

ASPA-7, válido para 2 huecos.
ASPA-9, válido para 3 huecos.

Ancho	Altura del aspa	
	ASPA-7	ASPA-9
30	1081.9	1436.7
45	1030.8	1398.8
60	953.4	1342.9
75	842.2	1266.8
90	680.6	1166.4
105	411.4	1034.6
120	-	856.7

Escalera

ESC - Escalera

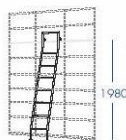

ESC - Escalera

GCO - Guía corredera Metrolineal (Máximo 3.6 m)

DESCRIPCION TÉCNICA

Producto : Sistema Jakin

Diseño : Abad diseño

Puertas Solapadas

PMS - Puertas batientes de Madera

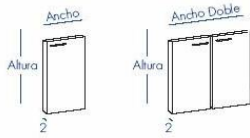

Opción cerradura. Siempre centrado en altura.

Incluye:

- Cerradura
- Mecanizados.
- Elementos auxiliares, embellecedores (puerta simple) y pestillos (puerta doble).

	Altura							
	②	③	④	⑤	⑥	⑧	⑩	⑫
Ancho	32	48	64	80	96	128	160	192
30	X	X	X	X	X	X	X	X
45	X	X	X	X	X	X	X	X
60	X	X	X	X	X	X	X	X
60 Doble	X	X	X	X	X	X	X	X
75	-	X	X	X	-	-	-	-
75 Doble	X	X	X	X	X	X	X	X
90 Doble	X	X	X	X	X	X	X	X

PVS - Puertas batientes de Vitrina

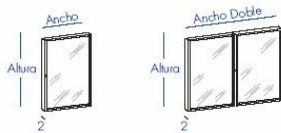

	Altura							
	②	③	④	⑤	⑥	⑧	⑩	⑫
Ancho	32	48	64	80	96	128	160	192
30	X	X	X	X	X	X	X	X
45	X	X	X	X	X	X	X	X
60	X	X	X	X	X	X	X	X
60 Doble	X	X	X	X	X	X	X	X
75	-	X	X	X	-	-	-	-
75 Doble	X	X	X	X	X	X	X	X
90 Doble	X	X	X	X	X	X	X	X

PTS - Puertas Trampón de Madera

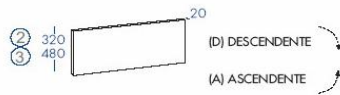

	AIT - ②	AIT - ③
Frente ancho 60 cm	X	X
Frente ancho 75 cm	X	X
Frente ancho 90 cm	X	X

PVHS - Puertas Trampón de Vitrina

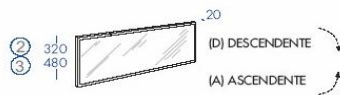

	AIT - ②	AIT - ③
Frente ancho 60 cm	X	X
Frente ancho 75 cm	X	X
Frente ancho 90 cm	X	X

DESCRIPCION TÉCNICA

Producto : Sistema Jakin

Diseño : Abad diseño

Cajones Solapados

CS16 - Cajones

F/30 F/45 F/60

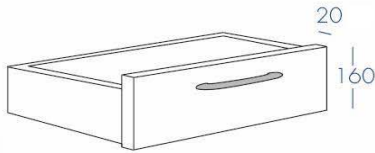

Cajón ancho 45 cm
Cajón ancho 60 cm
Cajón ancho 75 cm
Cajón ancho 90 cm

X	X	X
X	X	X
X	X	X
X	X	X

INSTRUCCIONES : FÁCIL DESMONTAJE DEL CAJON

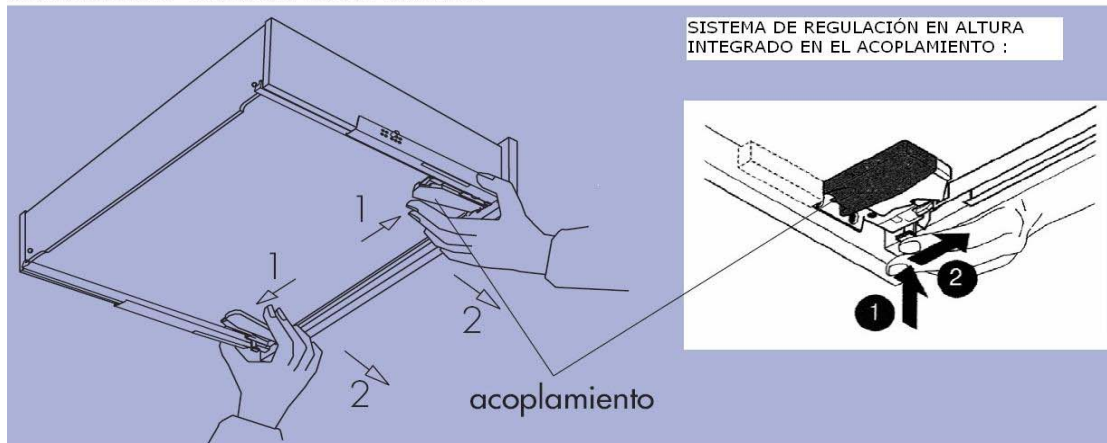

CSA - Cajones Archivadores

F/45 F/60

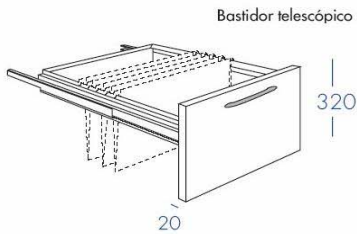

Bastidor telescópico metálico.

Cajón ancho 45 cm
Cajón ancho 60 cm
Cajón ancho 75 cm
Cajón ancho 90 cm

X	X
X	X
X	X
X	X

COMPLEMENTOS

CCA - Cerradura en Cajones (Son cajones antivuelco)

Para Fondos 45 y 60
Para Anchos 45 y 60

Para Fondos 45 y 60
Para Ancho 45

Altura



Altura









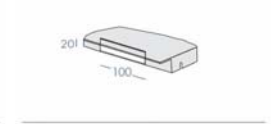
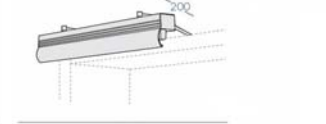
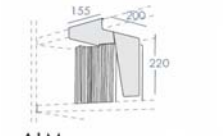
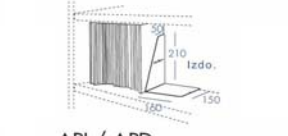
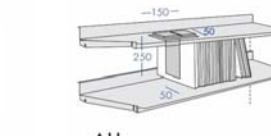
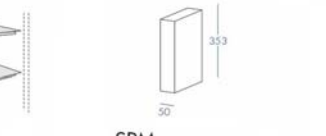
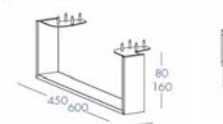

DESCRIPCION TÉCNICA

Producto : Sistema Jakin

Diseño : Abad diseño

Accesorios

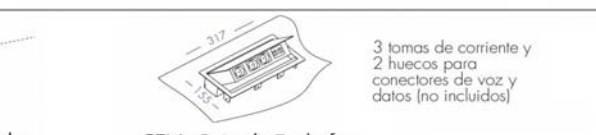
<p>AT - Atril</p> 	<p>BCD - Bandeja de CD</p> 	<p>PRM - Porta rótulos</p> 	<p>LUM - Luminaria</p> 
<p>Atril ancho 45 Atril ancho 60</p>	<p>Bandeja aluminio 60 cm Bandeja aluminio 90 cm Bandeja aluminio 120 cm</p>	<p>Para canto metálico</p>	<p>Metro lineal. Desde 61.5 cm hasta 310 cm (ambos inclusive) Incorpora interruptor</p>
<p>Apoya libros y soportes</p>			
<p>ALM</p> 	<p>API / APD</p> 	<p>ALI</p> 	<p>SPM</p> 
<p>Estante Madera</p>	<p>Estante Madera o metálico (izdo) Estante Madera o metálico (dcho)</p>	<p>Estante metálico</p>	<p>Soporte madera</p>
<p>Patas</p>			
<p>PID - Pata Inoxidable Doble</p> 	<p>F/45 F/60</p> 	<p>PSD - Pata Soporte Divisiones</p> 	<p>PFA - 70 PFB - 70 PFB - 56</p> 
<p>Alt - 8 Alt - 16</p>	<p>X X X X</p>	<p>Alt - 8 Alt - 16</p>	<p>Pata de aluminio Pata de madera adultos Pata de madera niños</p>
<p>R - Ruedas</p> 	<p>PAC - Pasacables</p> 	<p>CEN- Caja de Enchufes</p>  <p>3 tomas de corriente y 2 huecos para conectores de voz y datos (no incluidos)</p>	
<p>Rueda Alt-10.5 (50 Kg) Rueda Alt-13.5 (70 Kg)</p>		<p>Caja de enchufes 31,7 x 15,5 x 7</p>	